



SENSOR

Mono Basin Sensor Tap

Product Code: SENSOR7/D

Finish: Chrome

Features

- Construction:** Brass
- Valve/Cartridge type:** Electro Valve
- Supply:** Suitable For High Pressure Systems
- Working Pressures:** 0.5 - 5.0 bar
- Inlet connections:** 1/2" BSP
- Flexi or Copper:** Flexi Tails

- Suitable For Cold Or Premixed Water
- Moisture And Water Resistant Control Unit
- Choice Of Battery Or Mains Power
- Battery Operated, Requires 4 X Aa Batteries
- Recommended For Use With Blending Valve
- Products Which Are Easy To Use By All The Family

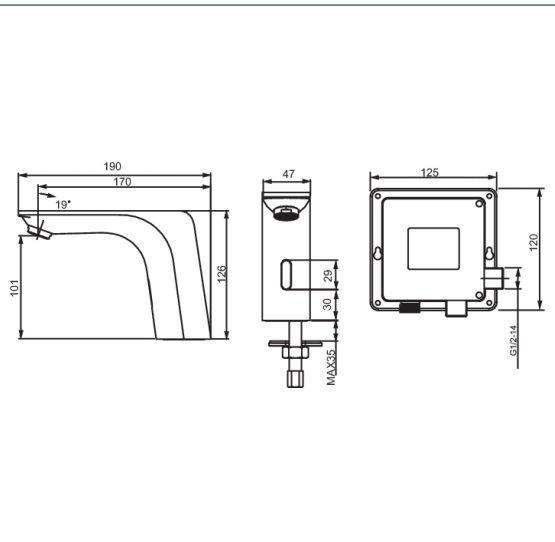

*Please refer to website for full warranty details.

Flow (Bar - l/min, open outlet)

Spout

Flow 0.1	Flow 0.3	Flow 0.5	Flow 1.0	Flow 2.0	Flow 3.0	Flow 4.0	Flow 5.0
0	0	5.7	5.7	5.7	5.7	5.7	5.7



2003387

