

Satinjet®

KIRI MKII LOW FLOW WALL SHOWER ROSE



Satinjet®. The unmistakable feeling of 300,000 droplets per second.

Unlike conventional showers, Satinjet uses unique twin-jet technology to create optimum water droplet size and pressure, with over 300,000 droplets per second providing greater warmth and coverage. The result is an immersive, full-body experience.

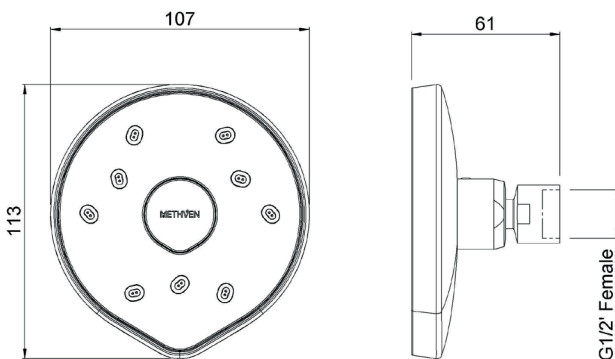

CONSTRUCTION: Brass bracket

CLASSIFICATION: Suitable for mains pressure only

INLET CONNECTIONS: 1/2" BSP Female

WORKING PRESSURE: 150 - 500kPa

OPERATING TEMPERATURE: 5 °C - 70 °C

- Low maintenance single function Satinjet® shower
- Easy clean coating on faceplate
- Tamper resistant flow restrictor
- Optimized to 5.7 l/pm
- Does not operate on all instantaneous hot water systems
- 4 star WELS rated on mains pressure (5.5 l/m)

KRLFWSCP

Chrome Faceplate

<http://www.methven.com/nz/kiri-satinjet-low-flow-showerhead>