

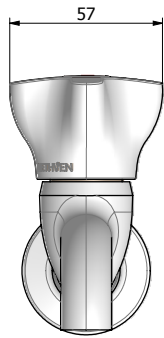

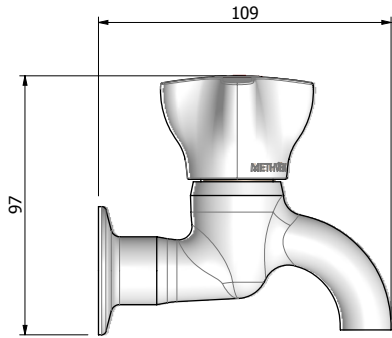





REV	DESCRIPTION	DATE	BY	ECA
-----	-------------	------	----	-----



SP080105	
SP080106	
122904	
	
HAAWCP	
	
SP112	

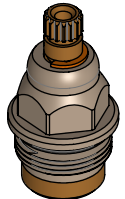
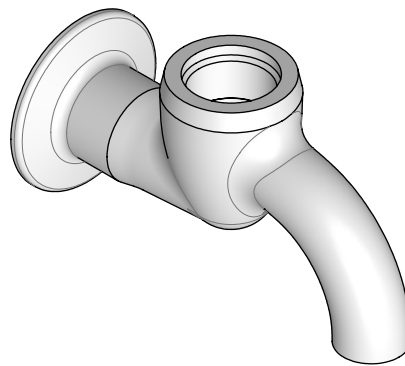

**Process Control Notes:**  
 □ = Significant Characteristics  
 □ = Customer Significant Features  
 Ⓢ = Safety Critical Features  
 All identified features are required to be produced with a process Cpk ≥ 1.33

**Dimensions in mm**  
  
 Scale: 1:2  
**DO NOT SCALE**

TOLERANCES UNLESS SPECIFIED OTHERWISE	
LINEAR 0 ± 0.4 0.0 ± 0.2 0.00 ± 0.1	ANGLES ± 3° SURFACE FINISH: 1.6/√ CONCENTRICITY © 0.1 ALL Ø ABOUT COMMON CENTRELINE

DRAWN: C Bauer 20/06/2016	CHECKED: Select checked by
MATERIAL: Refer parts	MASS: 614 g
COLOUR: Specify	FINISH: Specify
DESCRIPTION: <b>AWA TUB TAP CP - SP</b>	

<b>mETHVEN LIMITED</b> Private Bag 19996, Auckland 1746 447 Rosebank Road, Avondale, Auckland 1026 PH (+649) 829-0429 FAX (+649) 829-0439	Sheet 1 of 1
	Sheet size A3
DWG. No: <b>AW483</b>	REV: <b>A</b>

METHVEN\_PRODUCT\_TAP\_04