

METHVEN

SHOWERS & TAPWARE

Collection 2017

Introducing Rua, the new shape with Aurajet® technology. Page 22

View new matte black showers & taps. Pages 18 & 34

Trial a Methven shower handset for 30 days for just \$1. Conditions apply. Pages 14 & 24





Creating amazing water
experiences since

1886

Creating amazing water experiences is what we do every day at Methven, and have done since 1886 when George Methven first started as a producer of brass and iron hardware in Dunedin, New Zealand.

Today, Methven is world renowned for beautifully designed, award-winning showers, taps and valves. It all stems from our knowledge of water. Our unique history as an island nation has taught us to take care of nature's most precious resource.

Over the years we have learned how to harness its power to cleanse, calm, refresh and invigorate. And it's this expertise - combined with our passion for design and innovation - that fuels our ongoing mission to create amazing water experiences, just for you.



Icons Menu

To help you to identify important product features, we have placed icons beside each product. When you're browsing through the brochure, simply come back to this page and refer to each icon meaning.



ALL PRESSURE DESIGN
Suitable for all water pressure installations (mains, unequal and equal low) above 35kPa.



MAINS PRESSURE DESIGN
Suitable for mains water pressure installations above 150kPa.



EQUAL LOW PRESSURE DESIGN
Suitable for equal low water pressure installations 120kpa and below.



ECO BRASS®
Made with lead-free EcoBrass® to protect water quality and for enhanced corrosion resistance.



DZR BRASS
Dezincification Resistant (DZR) brass bodies last longer and help maintain water quality.



THERMOSTATIC MIXING TECHNOLOGY
Thermostatic mixing technology monitors and continually adjusts the temperature level preventing cold shocks or hot scalds.



LIFEMARK™ APPROVED PRODUCT
Designed to be easy to use and accessible for everyone, regardless of age and ability.



NEW PRODUCT



\$1 TRIAL
Trial this handset for 30 days for just \$1



COOL-TO-TOUCH TECHNOLOGY
Ensures the exterior never gets warmer than the mixed water temperature resulting in a safer shower environment.



EASY DIY INSTALLATION
Replace your shower handset on your own – no need for a plumber.



FLEXIBLE RAIL INSTALLATION
Adjustable mounting brackets for easy retrofit to existing installation holes.



CONTROL WATER DIRECTION
The directional aerator includes a built-in swivel that enables you to manually adjust the direction of your water and minimise splashback. (Perfect for taps that sit directly over the sinkhole).



SWIVEL SPOUT
Smooth, elegant and simple to use, our swivel spouts give you 360° control of your water flow.

Lifemark
CERT™

PRODUCT PARTNER

Lifemark™ independently certifies homes and products that have been designed to be easy to use and accessible for everyone, regardless of age and ability.

A Lifemark™ Approved Product is tested to meet age friendly Lifemark™ Standards of usability adaptability and safety.

To find out more visit www.lifemark.co.nz

IMPORTANT: KNOW YOUR WATER PRESSURE.

When choosing your showers and tapware it is important to know what water pressure your home has. New Zealand homes have three different types:

- Mains
- Unequal
- Equal Low

While most Methven products are designed to operate on all pressure installations, some products require mains pressure to operate effectively.

1. HOW TO CHECK YOUR WATER PRESSURE:

If you have...

- **Electric Water Heaters (Hot Water Cylinders)**
Check the label on cylinder, and look for the words mains pressure or low pressure. Low pressure means you have Unequal or Equal Low pressure.

- **Gas Water Heaters & Heat Pump Hot Water Heaters**
You will have mains pressure.

- **Solar Water Heaters & Tank Water Supply**
These can vary considerably, so check with your plumber.

Again, if you're unsure ask your plumber.

2. LOOK FOR THE ICON THAT CORRESPONDS TO YOUR PRESSURE:

The operating pressure on each product is clearly labelled using the following icons:



MAINS PRESSURE.
Operates on mains pressure installations above 150kPa.



ALL PRESSURE.
Operates on all pressure installations above 35kPa; this is mains or unequal.



EQUAL LOW PRESSURE.
Operates on equal low pressure installations 120kpa and below.

Contents

Our Story 04

Bathroom 10

AURAJET TECHNOLOGY COLLECTION 14

Aio	16
Rua	22

SATINJET TECHNOLOGY COLLECTIONS 24

Tahi	26
Koha	28
Waipori	32
Kiri & Kiri Low Flow	38
Maku	42
Futura	44

AIRSTREAM SHOWER 48

Alpha	48
-------	----

CONVENTIONAL SHOWERS 49

Milano & Futura	49
-----------------	----

OVERHEAD SHOWERS 50

STANDALONE TAPWARE COLLECTIONS 54

Aroha	54
Surface	56
Minimalist	58
Awa	60
Belaire	61
Blaze	62
Celeste	63
Glide	64
Neon	65
Promix	66
Bath Fillers	67

SPOUTS 68

Kitchen 70

SINK MIXERS 72



Designed with you in mind

We want to make your experiences with water truly memorable. To do this we spend a lot of time studying and researching what people want, anticipating even the smallest of needs to deliver truly amazing water experiences.

Every detail is considered. From optimising the spray from our shower heads for better warmth and coverage; to a sliding switch instead of a conventional rotating head to make changing shower functions easy even with wet, slippery hands; to a built-in footrest for shaving your legs. Small details of your entire bathroom experience have been improved to create a big impact - and always designed with you in mind.



Steve Dixon

Toolmaker
29 years of service

Guaranteed quality

We're proud to stand by each and every one of our products with a 20-year or lifetime warranty.

The reason for this is simple: we design and engineer our products here in New Zealand, so that we have control over the process from start to finish. We constantly push for perfection. In fact there is not a single component that hasn't been considered and refined for quality and durability at every stage - from design and engineering right through to manufacturing, crafting and even packaging.



Committed to the environment

At Methven we're committed to protecting the planet and reducing our environmental impact to help conserve the earth's natural resources.

Water is the earth's most precious commodity. Currently around one fifth of the world lives in a water scarce region. And with water usage growing at twice the population rate, its preservation will only become more vital in years to come.

That's why at Methven we make taking care of water a primary focus in every product we develop.

For example, did you know that your shower uses around 30% of your household water consumption? So we've developed innovative technologies - such as Satinjet and Aurajet - that deliver a luxurious shower experience, all whilst actually using less water.

Methven. Conserving energy and water to protect
the planet for generations to come.

Lake Wakitipu
Queenstown, NZ

Your bathroom, the choice to relax or revitalise

Your bathroom plays a vital role in your day. It invigorates you in the morning and relaxes you in the evening. So when you take on a bathroom project, be sure to consider the things that are most important to you with the help of this quick guide.

1. DECIDE WHAT TYPE OF BATHROOM YOU NEED:

When planning your new bathroom it's important to begin by thinking about how it will be used and by whom. People's requirements can often be very different:

Family bathroom: In a family bathroom you want to create a space that caters for growing families.

2. MAKE A LIST:

Before planning your layout think carefully about what you like and dislike about your current bathroom. Make a list and prioritise which features you'd most like to see in your new bathroom. Maybe it's an oversize walk-in shower, a large vanity with two sinks, a separate enclosure for your toilet, or a large free-standing bath.

3. GET INSPIRATION:

Gather inspiration of bathrooms you like from magazines and the internet. This could help when you're planning your layout.



Ensuite: An ensuite should be a sanctuary that's both luxurious and practical – a space where you can escape and relax.

Guest bathroom: Here you want to create a space that is both welcoming and pampering.

Rental property: Reliability and durability are the most important when selecting products for a rental property.



Some handy tips

Whether it's a new home build, renovation or a quick refresh, Methven has you covered with showers and tapware to suit any bathroom.

QUICK BATHROOM REFRESH

This can be as easy as changing your shower, either the shower handset or the whole rail shower. It's not difficult to do – either by screwing in a new handset on to your existing hose, or retro-fitting a new rail shower with adjustable mounting brackets so there's no need to drill additional holes. You'll be surprised at how a little added shower luxury can improve your day.

NEW BUILDS AND RENOVATIONS

When you're ready to choose bathroom fittings, start with the shower first. Why? Because the shower is an important space. You spend a lot of time in it and for many it's the only time of day when you get some 'me' time.

4. PLANNING YOUR LAYOUT

Your new bathroom layout can make all the difference, so be sure to plan carefully:

Bathtub – These days many people are trading or downsizing their bath for a luxurious walk-in shower. This can be a great option, although you may want to consider retaining at least one bath in the house – it can add to the value of your property.

Vanity – The vanity plays an integral role in your bathroom – choose a spot that won't interfere with your traffic, and make sure there's room above for mirror and wall cabinets.

Shower – Make the best use of space in small bathrooms by going for an open walk-in shower that doesn't need a curtain or door.

Plumbing Practicalities – Plumbing is a major cost in any bathroom project. In a renovation, try to keep costs down by limiting the need for adjusting your existing plumbing set-up.



Your shower experiences

Your shower should be a highlight of your day, transforming body and mind. But everyone has their own idea of the perfect shower. That's why at Methven we've spent a huge amount of time researching people's preferences, and creating innovations that turn your shower time into an amazing experience, every time.



Aurajet°

Our most invigorating shower experience ever.

20% more spray force and twice the amount of water on your skin than a conventional shower*.

* Compared to a Methven Conventional Shower at 9L per minute.



Satinjet°

A sensation only your skin can truly understand.

An amazing full-body shower sensation. Satinjet turns an everyday ritual into an experience like no other.



Airstream™

Like your own personal rain shower.

Airstream™ technology mixes air with water to create a refreshing, rain-like more voluminous shower experience.

Which shower?

There's an abundance of different shower types to choose from across the Methven range. Here's a quick guide to ensure you choose the right shower for your bathroom environment:

<p>RAIL SHOWER</p> <p>Offers great flexibility – height adjustability so the smallest or tallest users can enjoy a great shower, plus a handset that can be picked up for direct body showering. Perfect for the family bathroom.</p>	<p>SHOWER SYSTEM</p> <p>The ultimate shower for those who want the best of both worlds. Enjoy the flexibility of a rail shower with the added luxury of an overhead shower. Great for en suites.</p>	<p>WALL SHOWER</p> <p>Compact, durable and easy to clean. A popular choice for confined areas, commercial spaces and rental properties.</p>	<p>OVERHEAD SHOWER</p> <p>For those who want an elegant yet minimalist look and a fully immersive experience. Overhead Showers are the ideal choice.</p>
		<p>HAND SHOWER</p> <p>The simplicity of a fixed-point shower with the versatility of a movable showerhead. Can also be a handy addition to your bath or combined with an overhead for a more luxurious experience.</p>	<p>HI RISE SHOWER</p> <p>A wall shower with the added bonus of height adjustability. Works well in a family bathroom.</p>

METHVEN

Aurajet®

The next generation of showering has arrived.

Introducing Aurajet®. Our most advanced, most invigorating shower experience ever, that turns conventional showering on its head.

Invisible nozzles generate individual jets of water that collide against precisely angled surfaces hidden within the contours of the unique halo-shaped showerhead.

The result is a stunning fan of luxuriously dense droplets that delivers a highly efficient shower with 20% more spray force and twice the amount of water contact on your skin than a conventional shower*. All this adds up to an enveloping warmth that has to be felt to be believed, and a heavenly experience that puts you in a great space, every time you shower.



\$1 TRIAL – Experience the amazing benefits of Aurajet in your own home. **Trial the Aio Handset for 30 days for just \$1.** Conditions apply, to start your trial visit methven.com



20%
MORE SPRAY FORCE*

2x
THE AMOUNT OF
SKIN CONTACT*

* Compared to a Methven Conventional Shower at 9L per minute.

Aurajet® Aio

The Aio shower has an intriguing contemporary look and, within it's distinctive halo-shaped showerhead, employs groundbreaking Aurajet technology to deliver a fullbodied spray with maximum body contact and all-over warmth. It's our most advanced, most invigorating shower experience yet.

AURAJET

A stunning fan of luxuriously dense droplets that deliver a highly efficient shower with 20% more spray force and twice the amount of water on your skin*.

* Compared to a Methven Conventional Shower at 9L per minute.

\$1 TRIAL

Experience the amazing benefits of Aurajet in your own home. Trial the Aio Handset for 30 days for just \$1.

Conditions apply, visit methven.com for details



ULTRA WIDE COVERAGE

A full-bodied spray for all-over warmth and maximum body contact.



1.



2.



3.



4.



5.



6.



7.



1. AIO HANDSET

WELS mains pressure
3★ 9L/MIN

CHROME > AOHSCP
WHITE > AOHSCPWH
MIDNIGHT > AOHSCP3



2. AIO SHOWER SYSTEM

Drencher WELS mains pressure
2★ 9.5L/MIN

Handset WELS mains pressure
3★ 9L/MIN

CHROME > AOSSCP
WHITE > AOSSCPWH
MIDNIGHT > AOSSCPC3



3. AIO RAIL SHOWER

WELS mains pressure
3★ 9L/MIN

CHROME > AOSRCP
WHITE > AOSRCPWH
MIDNIGHT > AOSRCP3



4. AIO HAND SHOWER

WELS mains pressure
3★ 9L/MIN

CHROME > AOWBCP
WHITE > AOWBCPWH
MIDNIGHT > AOWBCPC3



5. AIO WALL SHOWER ON SHORT ARM

WELS mains pressure
3★ 9L/MIN

CHROME > AOSACP
WHITE > AOSACPWH
MIDNIGHT > AOSACP3



6. AIO OVERHEAD SHOWER

WELS mains pressure
2★ 10.5L/MIN

CHROME > AOOSCP
WHITE > AOOSCPWH
MIDNIGHT > AOOSCP3



7. AIO HI RISE SHOWER

WELS mains pressure
3★ 8.5L/MIN

CHROME > AOHRCP
WHITE > AOHRCPWH
MIDNIGHT > AOHRCP3



To complete the look match with:
Aio Tapware - See page 20
Aroha Tapware - See page 54
Maku Tapware - See page 42



1.



2.



3.



4.



1. AIO RAIL SHOWER

WELS mains pressure
3★ 9L/MIN
MATTE BLACK > AOSRBK



2. AIO BASIN MIXER

WELS mains pressure
4★ 7L/MIN
WELS low pressure
4★ 6.5L/MIN
MATTE BLACK > AOB BK



3. AIO SHOWER MIXER

MATTE BLACK > AOHP SBK



4. AIO WALL MOUNTED BATH SPOUT

MATTE BLACK > AOSPWBTBK



Aio

Complementing the Aio showerhead's unique halo form, Aio tapware combines intriguing sculptural contours with modern minimalist design.



LEAD FREE BRASS

Using Eco Brass® to protect water quality and for enhanced corrosion resistance (excludes Fastflow Aio Shower Mixer).

CERAMIC CARTRIDGE

Fitted with a quality ceramic cartridge for all-round durability and longevity.



1. AIO BASIN MIXER

WELS mains pressure
4★ 7L/MIN
WELS low pressure
4★ 6.5L/MIN

> AOBBCP



2. AIO MINI BASIN MIXER

WELS mains pressure
4★ 7.5L/MIN
WELS low pressure
6★ 4.5L/MIN

> AOBMCP



3. AIO WALL MOUNTED MIXER WITH SPOUT

WELS mains pressure
4★ 7L/MIN

> AOWBCP



4. AIO WALL MOUNTED BATH SPOUT

> AOSPBWBCP



5. AIO SHOWER MIXER

> AOHPSCP



6A. Fastflow® AIO SHOWER MIXER

> AOAPSCP



6B. Safeflow® AIO SHOWER MIXER

> AOSFSCP



7. AIO SHOWER MIXER WITH DIVERTER

> AOHPSDCP



Aurajet® Rua

The distinctive Rua shower takes geometric styling and softens the appearance with slightly rounded edges for a truly unique and contemporary look. Rua utilises the groundbreaking Aurajet technology to deliver better coverage and force within a wide balanced spray. It's our most advanced, most invigorating shower experience yet.

AURAJET

A stunning fan of luxuriously dense droplets that deliver a highly efficient shower with 20% more spray force and twice the amount of water on your skin*.

* Compared to a Methven Conventional Shower at 7.5L per minute.



WIDE COVERAGE

A wider, well-balanced spray for superior body coverage.



To complete the look match with:
Surface Tapware - See page 56
Kiri Tapware - See page 40

1.



2.



1. RUA HANDSET

WELS mains pressure
4★ 7.5L/MIN

CHROME > RUHSCP
WHITE > RUHSCPWH



2. RUA RAIL SHOWER

WELS mains pressure
4★ 7.5L/MIN

CHROME > RUSRCP
WHITE > RUSRCPWH



METHVEN

Satinjet®

A sensation only your skin can truly understand.

Turn an everyday ritual into a shower experience with award-winning Satinjet® technology from Methven.

Unlike conventional showers, Satinjet® uses unique twin-jet technology to create optimum water droplet size and pressure, with over 300,000 droplets per second. The result is an immersive, full-body shower sensation that transforms your regular shower into an experience like no other.

And because we know everyone has their own idea of the perfect shower, Methven has crafted a range of Satinjet® showers you can match to your individual needs – from gentle and enveloping to powerful and invigorating.

Satinjet® from Methven – prepare yourself for a truly sensational shower experience.



\$1 TRIAL – Experience the amazing benefits of Satinjet in your own home. Trial the Waipori Handset for 30 days for just \$1. Conditions apply, to start your trial visit methven.com



OUR RECOMMENDATIONS FOR LOW & UNEQUAL WATER PRESSURE

While all Sainjet showers are designed to operate on all pressure installations some are optimised to perform better than others on Unequal and Low Pressures. Here are our recommendations:

UNEQUAL – WAIPORI

Good balance between force and coverage.



LOW & UNEQUAL – KIRI

Good coverage and larger droplets.



LOW – MAKU

Compact spray to optimise the spray force.



Satinjet® Tahi

Combining contemporary functionality with classic lines and angles, each element of the Tahi collection is designed with you in mind. From delivering individual touches that heighten your shower experience, to the Tahi mixers' ergonomic design that brings a smooth, tactile element to simple functionality. The difference is in the detail.

SATINJET

A full-body shower experience, like no other. Satinjet's colliding twin jets produce over 300,000 droplets of water per second for the ultimate shower experience.

MASSAGE

The luxurious Satinjet experience with an added massage function for a more powerful spray - ideal for rinsing your hair.



ULTRA WIDE COVERAGE

A full-bodied spray for all-over warmth and maximum body contact.

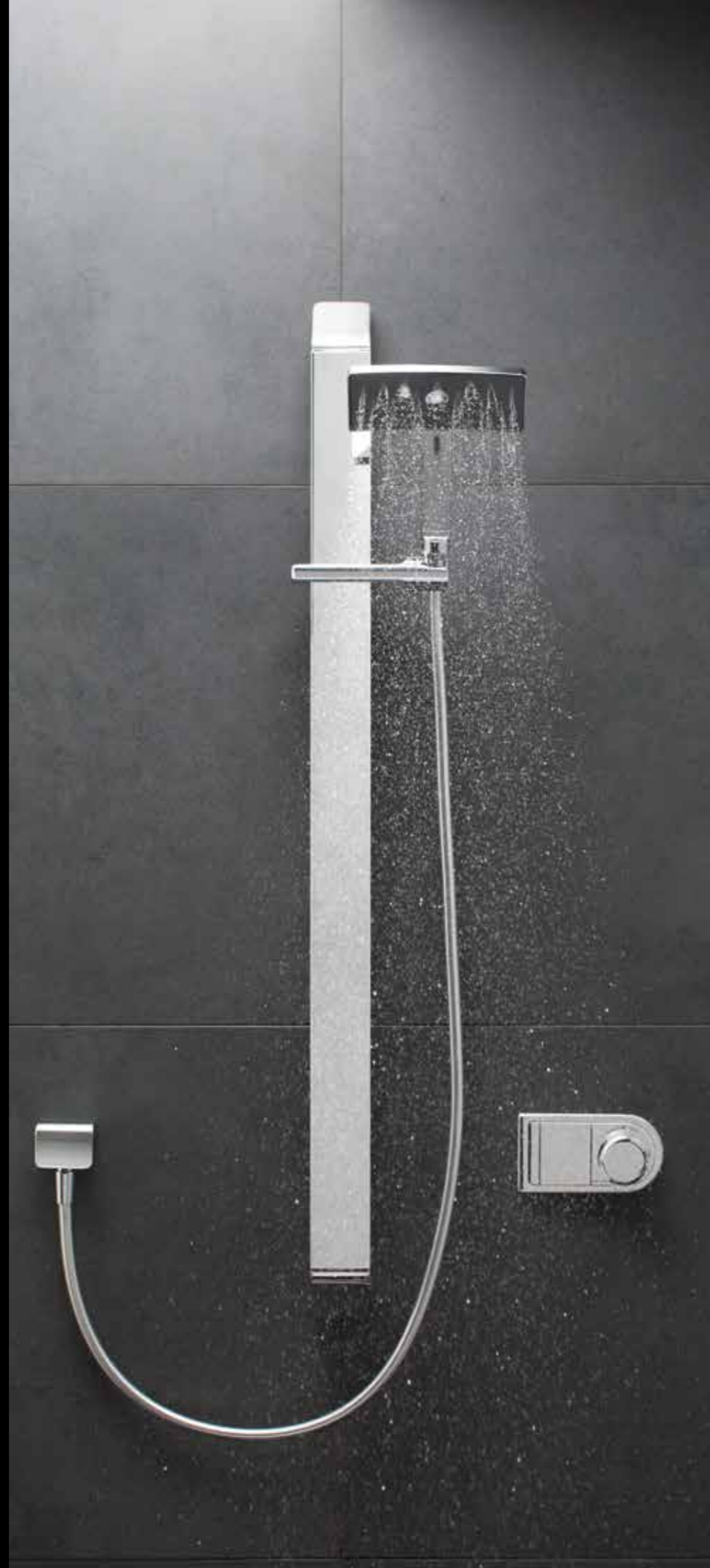

To complete the look match with:
Surface Tapware - See page 56
Kiri Tapware - See page 40

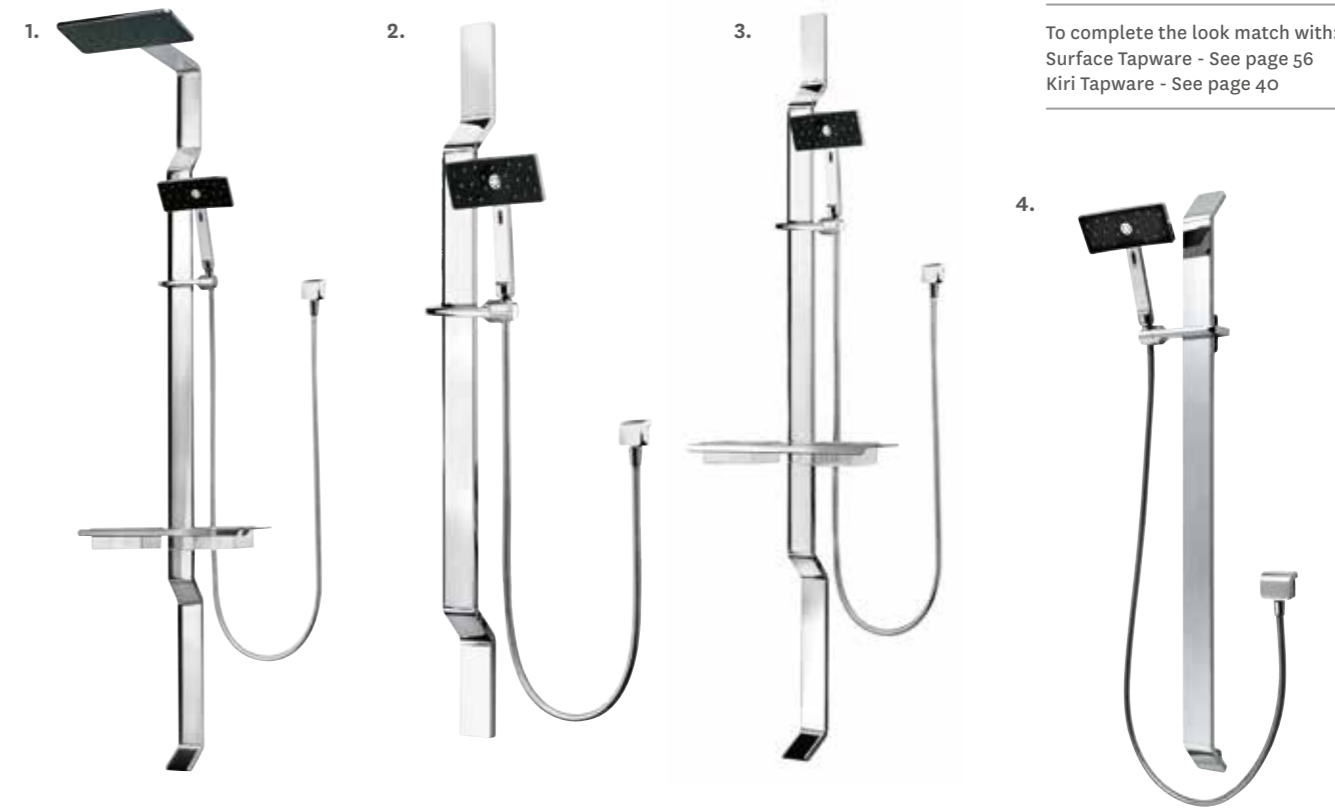

1. TAHI SHOWER SYSTEM

Drencher WELS mains pressure
2★ 12L/MIN
Handset WELS mains pressure
2★ 11L/MIN
> SHTACCP



2. TAHI RAIL SHOWER

WELS mains pressure
2★ 11L/MIN
> SHTACP



3. TAHI RAIL SYSTEM

WELS mains pressure
2★ 11L/MIN
> SHTASCP



4. TAHI RAIL SHOWER SHORT

WELS mains pressure
2★ 11L/MIN
> SHTASBCP



5. TAHI OVERHEAD SHOWER ON WALL ARM

WELS mains pressure
2★ 12L/MIN
> SHTAACP



6. TAHI HANDSET WITH HOSE

WELS mains pressure
2★ 11L/MIN
> TAHPCP



7. TAHI THERMOSTATIC DUAL FLOW MIXER

> TASHT2CP



8. TAHI THERMOSTATIC SINGLE FLOW MIXER

> TASHT1CP



9. TAHI SHOWER MIXER WITH DIVERTER

> TASHDCP



10. Fastflow® TAHI SHOWER MIXER

> TASHCP



Satinjet® Koha

A classic form with modern design accents, the Koha shower collection brings a distinctive design aesthetic. Organic curves meet crisp edges in a look that's as practical as it is beautiful.

SATINJET

A full-body shower experience, like no other. Satinjet's colliding twin jets produce over 300,000 droplets of water per second for the ultimate shower experience.

MASSAGE

The luxurious Satinjet experience with an added massage function for a more powerful spray - ideal for rinsing your hair.



ULTRA WIDE COVERAGE

A full-bodied spray for all-over warmth and maximum body contact.



1.



4.



5.



2.



3.



1. KOHA HI RISE SHOWER

WELS mains pressure
3★ 9L/MIN
WELS low pressure
3★ 5L/MIN
> K07423CP



2. KOHA RAIL SHOWER

WELS mains pressure
3★ 8.5L/MIN
WELS low pressure
3★ 8.5L/MIN

GRAPHITE > SHK0CP
WHITE > KOSRCPWH
SATIN CHROME > KOSRCPSC



3. KOHA SHOWER SYSTEM

Drencher WELS mains pressure
3★ 8.5L/MIN
Handset WELS mains pressure
3★ 8L/MIN

> K0SSCPGR



4. KOHA SHOWER ON UPSWEPT ARM

WELS mains pressure
3★ 9L/MIN
WELS low pressure
3★ 9L/MIN

> K0315CP



5. KOHA HANDSET WITH HOSE

WELS mains pressure
3★ 8.5L/MIN
WELS low pressure
3★ 8.5L/MIN

GRAPHITE > KOHPCP
WHITE > KOHSCPWH
SATIN CHROME > KOHSCPSC



To complete the look match with:
Koha Tapware - See page 30
Aio Tapware - See page 20
Maku Tapware - See page 42

Koha

Strong but timeless forms make this tapware perfect to complement the Koha shower range's distinctive fusion of classic and modern. A versatile look with a range of options to suit any home.



CERAMIC CARTRIDGE

Fitted with a quality ceramic cartridge for all-round durability and longevity.

LONGER LASTING TAPS

Dezincification Resistant (DZR) brass bodies last longer and help maintain water quality.



1. KOHA BASIN MIXER

WELS mains pressure
4★ 6.5L/MIN
WELS low pressure
4★ 7L/MIN
> KOBSLCP



2. KOHA WALL MOUNTED BATH SPOUT

> KOSP200CP



3. KOHA WALL MOUNTED MIXER WITH SPOUT

WELS mains pressure
4★ 6.5L/MIN
> KOWSLCP



4. KOHA WALL MOUNTED MIXER WITH BACKPLATE AND SPOUT

WELS mains pressure
4★ 6.5L/MIN
> KOWSLFCP



5. Fastflow® KOHA SHOWER MIXER

> KOSHCP



6. KOHA SHOWER MIXER WITH DIVERTER

> KOSHDCP



7. KOHA SHOWER MIXER

> KOHPUSCP



Satinjet® Waipori

In our distinctive Waipori collection, we have taken traditional geometric shapes and subtly tapered them for the modern bathroom. Attractive, slimline and compact.

SATINJET

A full-body shower experience, like no other. Satinjet's colliding twin jets produce over 300,000 droplets of water per second for the ultimate shower experience.

\$1 TRIAL

Experience the amazing benefits of Satinjet in your own home. Trial the Waipori Handset for 30 days for just \$1.

Conditions apply, visit methven.com for details



OVERHEAD ULTRA WIDE COVERAGE

A full-bodied spray for all-over warmth and maximum body contact.



WIDE COVERAGE

A wider, well-balanced spray for superior body coverage.



To complete the look match with:
Waipori Tapware - See page 36
Kiri Tapware - See page 40
Surface Tapware - See page 56



1. WAIPORI HANDSET WITH HOSE

WELS mains pressure
3★ 8.5L/MIN
WELS low pressure
3★ 9L/MIN

GRAPHITE > WAHPCP
WHITE > WAHSCPWH



2. WAIPORI RAIL SHOWER

WELS mains pressure
3★ 8.5L/MIN
WELS low pressure
3★ 9L/MIN

GRAPHITE > SHWACP
WHITE > WASRCPWH



3. WAIPORI SHOWER SYSTEM

Drencher WELS mains pressure
3★ 8.5L/MIN
Handset WELS mains pressure
3★ 8L/MIN

> WASSCPGR



4. WAIPORI WALL SHOWER ON CONVENTIONAL ARM

WELS mains pressure
3★ 8.5L/MIN
WELS low pressure
3★ 8L/MIN

> WA215CP





























5. WAIPORI WALL SHOWER ROSE

WELS mains pressure
3★ 8.5L/MIN
WELS low pressure
3★ 9L/MIN

> WASRCP





- | | | | | | | |
|---|---|--|---|--|---|--|
| <p>1. WAIPORI RAIL SHOWER</p> <p>WELS mains pressure
3★ 8.5L/MIN
WELS low pressure
3★ 9L/MIN</p> <p>MATTE BLACK > WASRBK
MATTE BLACK & WHITE > WASRBKWH</p> <p>   </p> | <p>2. WAIPORI BASIN MIXER</p> <p>WELS mains pressure
4★ 6.5L/MIN
WELS low pressure
6★ 3.5L/MIN</p> <p>MATTE BLACK > WABBK</p> <p>   </p> | <p>3. WAIPORI SINK MIXER</p> <p>WELS mains pressure
4★ 6.5L/MIN
WELS low pressure
4★ 7L/MIN</p> <p>MATTE BLACK > WAKBK</p> <p>   </p> | <p>4. WAIPORI WALL MOUNTED BATH SPOUT</p> <p>MATTE BLACK > WASPW200BK</p> <p>   </p> | <p>5. WAIPORI WALL MOUNTED MIXER WITH SPOUT</p> <p>Coming November 2017
WELS mains pressure
4★ 7L/MIN</p> <p>MATTE BLACK > WAWSLBK</p> <p>  </p> | <p>6. Fastflow® WAIPORI SHOWER MIXER</p> <p>MATTE BLACK > WAAPSBK</p> <p>   </p> | <p>7. WAIPORI SHOWER MIXER WITH DIVERTER</p> <p>MATTE BLACK > WAHPSDBK</p> <p>  </p> |
|---|---|--|---|--|---|--|

Waipori

A softer, modern take on geometric styling that's beautiful to the touch.



CERAMIC CARTRIDGE
Fitted with a quality ceramic cartridge for all-round durability and longevity.

LONGER LASTING TAPS
Dezincification Resistant (DZR) brass bodies last longer and help maintain water quality.

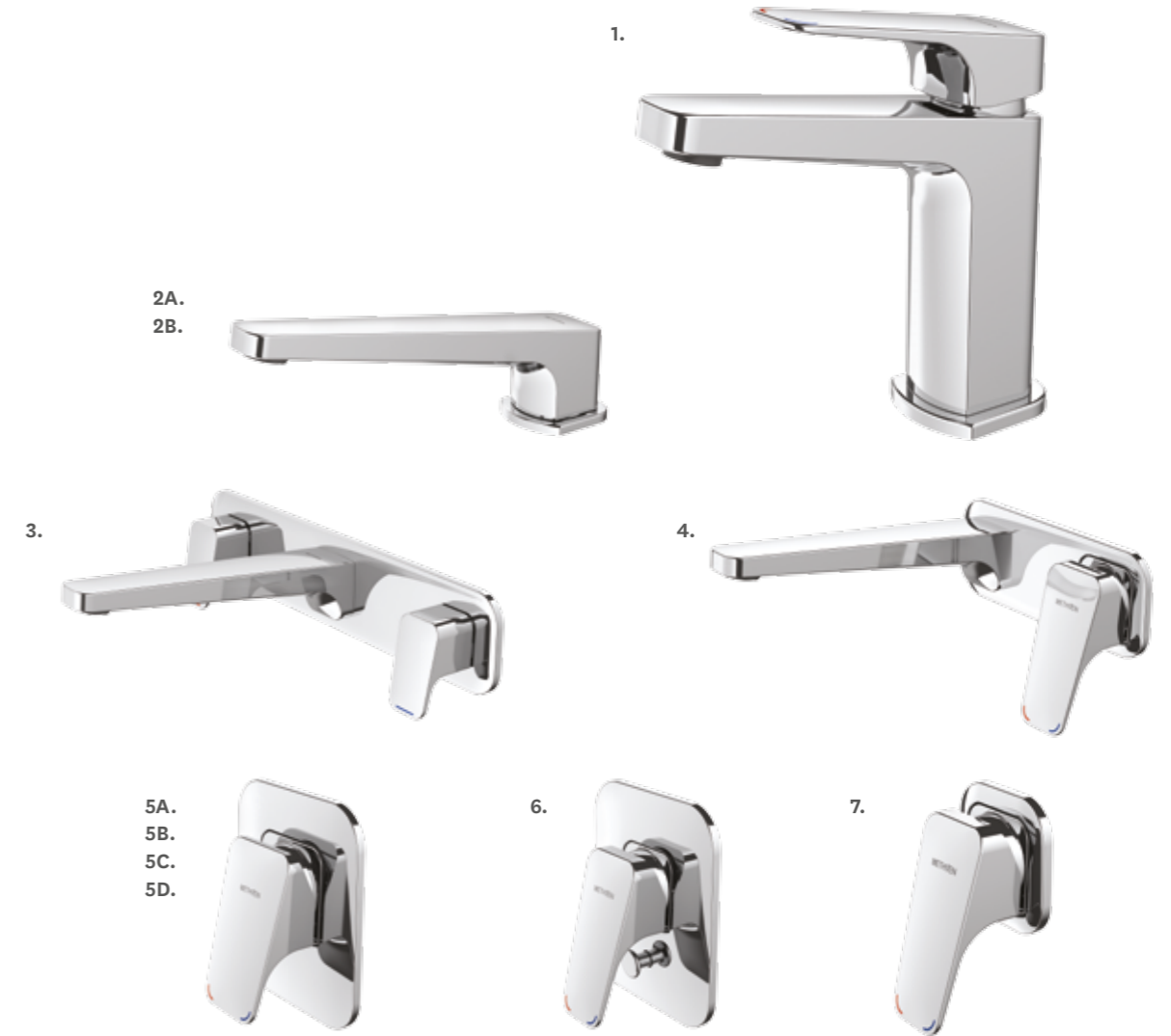

<p>1. WAIPORI BASIN MIXER</p> <p>WELS mains pressure 4★ 6.5L/MIN WELS low pressure 6★ 3.5L/MIN > WABCP</p>	<p>2A. WAIPORI HOB MOUNTED BATH SPOUT</p> <p>> WASPH200CP</p>	<p>2B. WAIPORI WALL MOUNTED BATH SPOUT</p> <p>> WASPW200CP</p>	<p>5B. Fastflow® WAIPORI SHOWER MIXER</p> <p>> WASHCP</p>
<p>3. WAIPORI 3 HOLE WALL MOUNTED SET</p> <p>WELS mains pressure 4★ 7L/MIN WELS low pressure 4★ 6.5L/MIN > WABWCP</p>	<p>4. WAIPORI WALL MOUNTED MIXER WITH SPOUT</p> <p>WELS mains pressure 4★ 7L/MIN > WAWSLCP</p>	<p>5A. WAIPORI SHOWER MIXER</p> <p>> WAHPSCP</p>	<p>6. WAIPORI SHOWER MIXER WITH DIVERTER</p> <p>> WASHDCP</p>
<p>5C. Safeflow® WAIPORI SHOWER MIXER</p> <p>> WASFCP</p>	<p>5D. Hyperflow® WAIPORI SHOWER MIXER</p> <p>> WAHFSCP</p>	<p>7. WAIPORI MINI SHOWER MIXER</p> <p>> WAHPUSCP</p>	

Satinjet® Kiri

Kiri is our answer for lovers of clean lines and strong, dynamic forms. This solid architectural style makes its presence known in your bathroom.

SATINJET

A full-body shower experience, like no other. Satinjet's colliding twin jets produce over 300,000 droplets of water per second for the ultimate shower experience.



OVERHEAD ULTRA WIDE COVERAGE

A full-bodied spray for all-over warmth and maximum body contact.



WIDE COVERAGE

A wider, well-balanced spray for superior body coverage.



1.

2.

1. KIRI SHOWER SYSTEM

Drencher WELS mains pressure
3★ 7.5L/MIN

Handset WELS mains pressure
3★ 8L/MIN

> SHKIDCP



2. KIRI HI RISE SHOWER

WELS mains pressure
3★ 9L/MIN
WELS low pressure
3★ 6.5L/MIN

> KI7423CP



3.



4.



5.



6.



7A.
7B.



8.



9.



10.



11.



3. KIRI HANDSET WITH HOSE

WELS mains pressure
3★ 8L/MIN
WELS low pressure
3★ 9L/MIN

> KIHPCP



4. KIRI LOW FLOW HANDSET WITH HOSE

WELS mains pressure
3★ 5L/MIN

> KIHPCP5



5. KIRI WALL SHOWER ON CONVENTIONAL ARM

WELS mains pressure
3★ 8.5L/MIN
WELS low pressure
2★ 10L/MIN

> KI215CP



6. KIRI OVERHEAD SHOWER

WELS mains pressure
3★ 7.5L/MIN
WELS low pressure
1★ 13L/MIN

FLUSH MOUNTED > KI200FCP
OVERHEAD SHOWER > KI200COP



7A. KIRI OVERHEAD SHOWER ON WALL ARM

WELS mains pressure
3★ 8.5L/MIN
WELS low pressure
2★ 11L/MIN

> KI200WCP



7B. KIRI OVERHEAD SHOWER ON CEILING ARM

WELS mains pressure
3★ 7.5L/MIN
WELS low pressure
2★ 11L/MIN

> KI200CCP



8. KIRI RAIL SHOWER

WELS mains pressure
3★ 8L/MIN
WELS low pressure
3★ 9L/MIN

> SHKICP



9. KIRI WALL SHOWER ON UPSWEPT ARM

WELS mains pressure
3★ 8.5L/MIN
WELS low pressure
2★ 10L/MIN

> KI315CP



10. KIRI WALL SHOWER ROSE

WELS mains pressure
3★ 8.5L/MIN
WELS low pressure
2★ 11L/MIN

> KISRCP



11. KIRI LOW FLOW WALL SHOWER ROSE

WELS mains pressure
3★ 5L/MIN

> KISRCP5



To complete the look match with:
Aio Tapware - See page 20
Maku Tapware - See page 42
Kiri Tapware - See page 40

Kiri

Bold and contemporary geometric forms offer a confident counterpoint to the rounded Kiri shower range for a confident statement in styling.



CERAMIC CARTRIDGE

Fitted with a quality ceramic cartridge for all-round durability and longevity.

LONGER LASTING TAPS

Dezincification Resistant (DZR) brass bodies last longer and help maintain water quality.



1. KIRI BASIN MIXER

WELS mains pressure
4★ 6.5L/MIN
WELS low pressure
4★ 6.5L/MIN

> KIBBCP



2. KIRI HI RISE BASIN MIXER

WELS mains pressure
4★ 6.5L/MIN
WELS low pressure
4★ 7L/MIN

> KIBHRCP



3. KIRI 3 HOLE BASIN SET

WELS mains pressure
4★ 6.5L/MIN
WELS low pressure
2★ 11L/MIN

> KIBHCP



4. KIRI 3 HOLE WALL MOUNTED SET

WELS mains pressure
4★ 6.5L/MIN
WELS low pressure
1★ 13.5L/MIN

> KIBWCP



5. KIRI WALL MOUNTED MIXER WITH SPOUT

WELS mains pressure
4★ 6.5L/MIN

> KIWSLCP



6. KIRI WALL MOUNTED BATH SPOUT

> KISP172CP



7. Fastflow® KIRI SHOWER MIXER

> KISHCP



8. KIRI SHOWER MIXER WITH DIVERTER

> KISHDCP



Satinjet® Maku

Designed as a natural evolution of the classic minimalist style, Maku is designed with compact, balanced proportions. The tapware delivers refined cylindrical forms and subtle planes for a simple elegant look.

SATINJET

A full-body shower experience, like no other. Satinjet's colliding twin jets produce over 300,000 droplets of water per second for the ultimate shower experience.

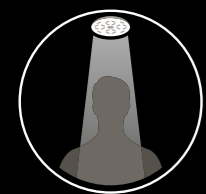

REGULAR COVERAGE

A compact and powerful spray for everyday showering.



To complete the look match with:
Aroha Tapware - See page 54
Aio Tapware - See page 20

1.



2.



3.



4.



5A.
5B.



6.



1. MAKU RAIL SHOWER

WELS mains pressure
3★ 7.5L/MIN
WELS low pressure
3★ 6L/MIN
> SHMAKCP



2. MAKU BASIN MIXER

WELS mains pressure
4★ 6.5L/MIN
WELS low pressure
6★ 4.5L/MIN
> MABCP



3. MAKU WALL MOUNTED BATH SPOUT

> MASPW210CP



4. MAKU WALL MOUNTED MIXER WITH SPOUT

WELS mains pressure
4★ 7L/MIN
> MAWSLCP



5A. Fastflow® MAKU SHOWER MIXER

> MASHCP



5B. Safeflow® MAKU SHOWER MIXER

> MASFCP



6. MAKU SHOWER MIXER

> MAHPUSCP



Satinjet® Futura

Our design team have made some subtle improvements to this traditional crowd-pleaser. With clean unpretentious lines, combining everyday luxury with water efficiency.

SATINJET

A full-body shower experience, like no other. Satinjet's colliding twin jets produce over 300,000 droplets of water per second for the ultimate shower experience.

MASSAGE

The luxurious Satinjet experience with an added massage function with an added massage function for a more powerful spray - ideal for rinsing your hair (excludes Futura FU).

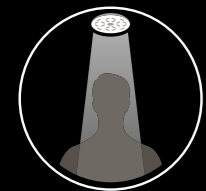

REGULAR COVERAGE

A compact and powerful spray for everyday showering.



To complete the look match with:
Futura Tapware - See page 46
Maku Tapware - See page 42
Aroha Tapware - See page 54

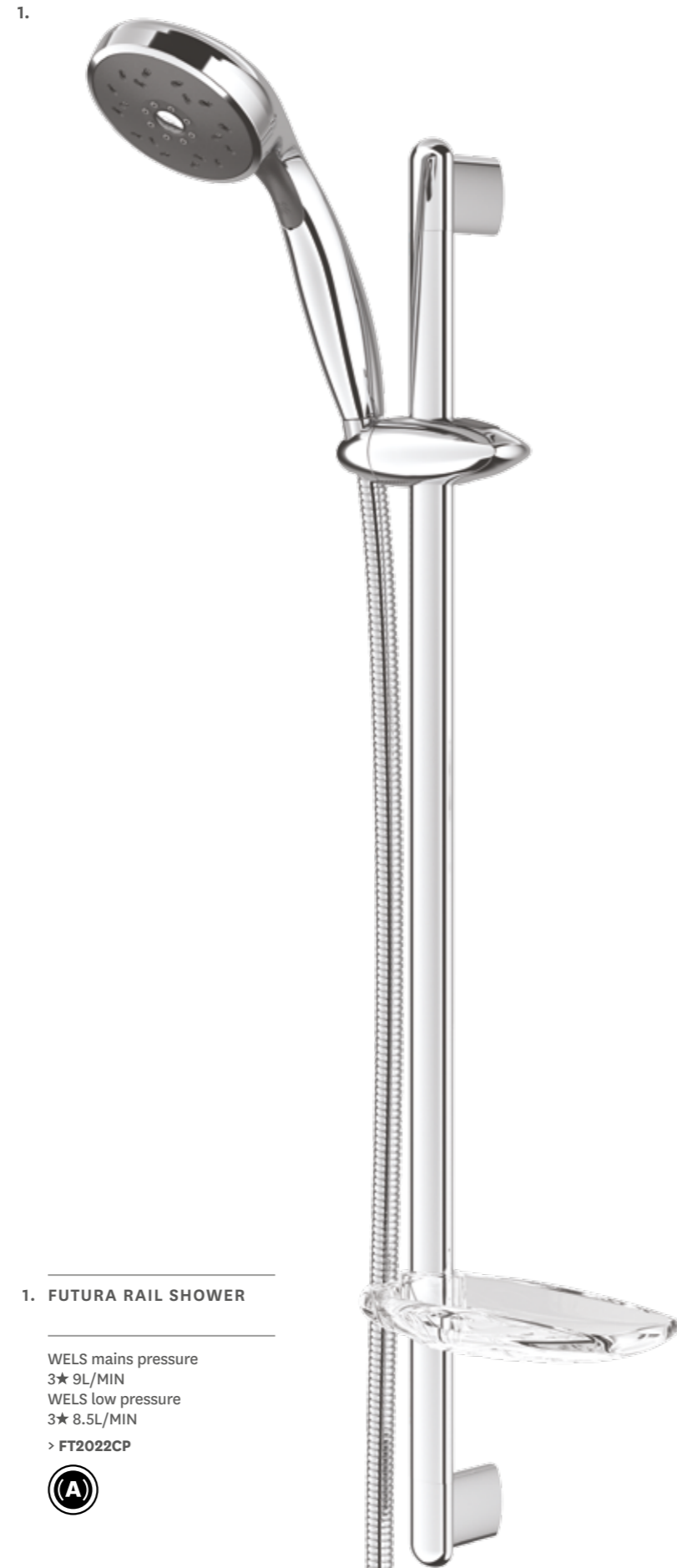

1. FUTURA RAIL SHOWER

WELS mains pressure
3★ 9L/MIN
WELS low pressure
3★ 8.5L/MIN

> FT2022CP



2. FUTURA HANDSET WITH HOSE

WELS mains pressure
3★ 9L/MIN
WELS low pressure
3★ 8.5L/MIN

> FT1022CP



3. FUTURA FU HANDSET WITH HOSE

WELS mains pressure
3★ 7.5L/MIN
WELS low pressure
3★ 6L/MIN

> FU1011CP



4. FUTURA FU RAIL SHOWER

WELS mains pressure
3★ 7.5L/MIN
WELS low pressure
3★ 6L/MIN

> FU2011CP



5. FUTURA WALL SHOWER ON CONVENTIONAL ARM

WELS mains pressure
3★ 9L/MIN
WELS low pressure
3★ 8.5 L/MIN

> FT215CP



6. FUTURA WALL SHOWER ON UPSWEPT ARM

WELS mains pressure
3★ 9L/MIN
WELS low pressure
3★ 8.5 L/MIN

> FT315CP



7. FUTURA HI RISE SHOWER

WELS mains pressure
3★ 9L/MIN
WELS low pressure
3★ 6.5L/MIN

> FT7423CP



Futura

A simple classic design range that's versatile enough to work with any style of bathroom.



CERAMIC CARTRIDGE

Fitted with a quality ceramic cartridge for all-round durability and longevity.

LONGER LASTING TAPS

Dezincification Resistant (DZR) brass bodies last longer and help maintain water quality.

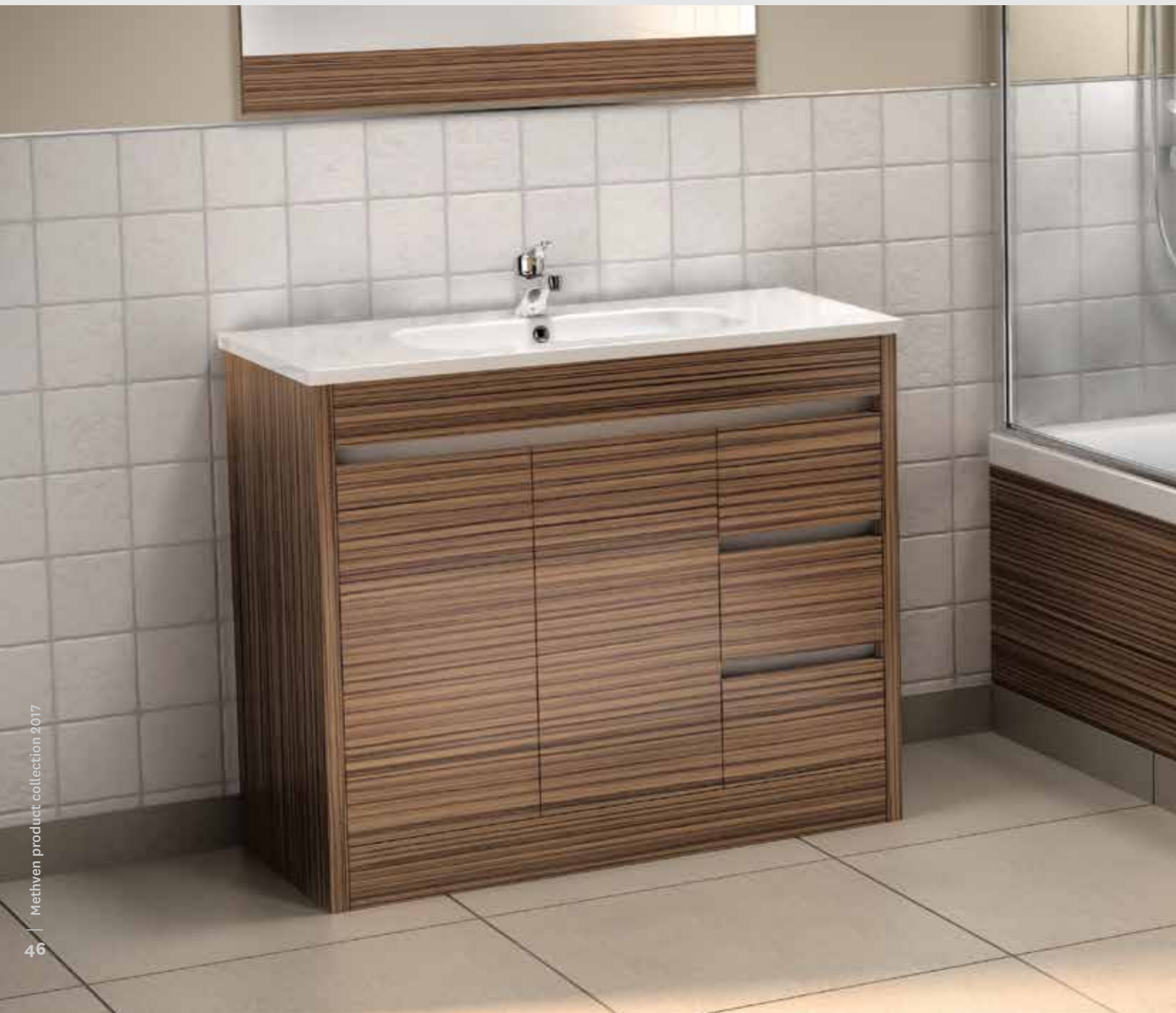

1. FUTURA BASIN MIXER

WELS mains pressure
3★ 8L/MIN
WELS low pressure
3★ 8.5L/MIN

> FT2050CP



2. FUTURA FU BATH MIXER

> FU2080CP



3. FUTURA SHOWER MIXER WITH DIVERTER

> FTSHDCP



4A. Fastflow[®] FUTURA SHOWER MIXER

> FT2010CP



4B. Hyperflow[™] FUTURA SHOWER MIXER

> FTHFSCP



Airstream™ Alpha

Integrating functionality with form, the Alpha shower delivers everyday elegance. Airstream technology delivers a rain-like, softer more voluminous shower that is simply refreshing.



AIRSTREAM

Airstream technology aerates each water droplet to increase its volume – thus creating a refreshing shower experience.



REGULAR COVERAGE

A compact and powerful spray for everyday showering.



To complete the look match with:
Aio Tapware - See page 20
Maku Tapware - See page 42
Aroha Tapware - See page 54

1.



1. ALPHA MKII RAIL SHOWER

WELS mains pressure
3★ 8.5L/MIN
> SHALCP2



Milano & Futura

We have revitalised the traditional shower experience, enhanced by leading-edge technology.

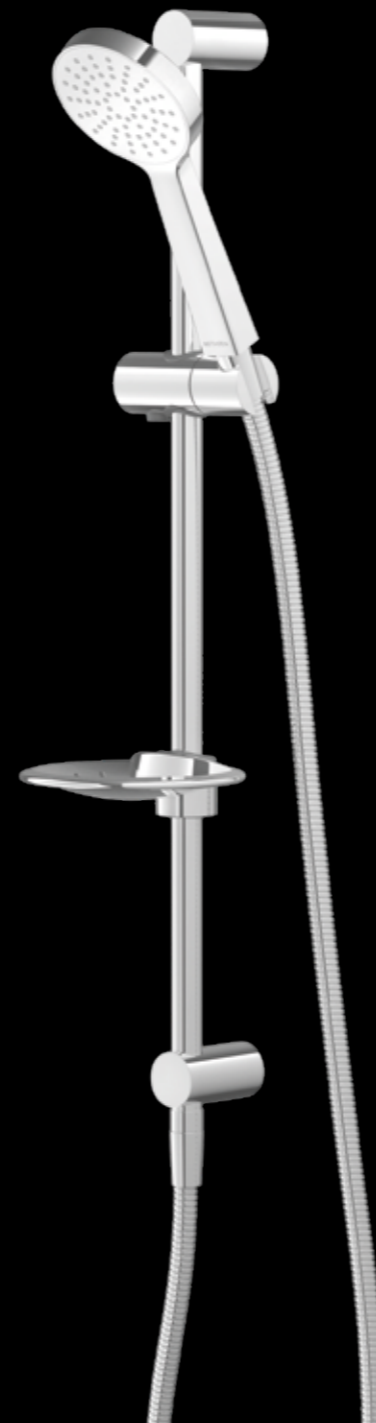

REGULAR COVERAGE

A compact and powerful spray for everyday showering.



To complete the look match with:
Aio Tapware - See page 20
Maku Tapware - See page 42
Aroha Tapware - See page 54

1.



1. MILANO MKII WET/DRY RAIL SHOWER

WELS mains pressure
3★ 8.5L/MIN
WELS low pressure
3★ 9L/MIN
> SHMLCP2



2.



2. FUTURA SHOWER ROSE

WELS low pressure
1★ 14L/MIN
> FUT15CP



Overhead Showers

Fixed overhead showers for an immersive, rain-inspired shower experience.



1. **Aurajet®**
AIO OVERHEAD SHOWER

WELS mains pressure
2★ 10.5L/MIN

CHROME > AOOSCP
WHITE > AOOSCPWH
MIDNIGHT > AOOSCP3



2. **Satinjet®**
SQUARE OVERHEAD
SHOWER ON CEILING ARM

WELS mains pressure
3★ 7.5L/MIN
WELS low pressure
2★ 11L/MIN

> OSQ230CCP



3. **Satinjet®**
KIRI OVERHEAD SHOWER
ON CEILING ARM

WELS mains pressure
3★ 8.5L/MIN
WELS low pressure
2★ 11L/MIN

> KI200CCP



4. **Satinjet®**
KIRI OVERHEAD SHOWER
ON WALL ARM

WELS mains pressure
3★ 8.5L/MIN
WELS low pressure
2★ 11L/MIN

> KI200WCP



5. **Satinjet®**
KIRI OVERHEAD SHOWER

WELS MAINS PRESSURE
3★ 8.5L/MIN
WELS LOW PRESSURE
2★ 11L/MIN

> KI200CP



6. **Satinjet®**
KIRI FLUSH MOUNTED
OVERHEAD SHOWER

WELS mains pressure
3★ 7.5L/MIN
WELS low pressure
1★ 13L/MIN

> KI200FCP



7. **Satinjet®**
SQUARE OVERHEAD
SHOWER ON WALL ARM

WELS mains pressure
3★ 8.5L/MIN
WELS low pressure
2★ 11.5L/MIN

> OSQ230WCP

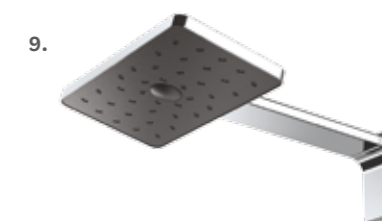

8. **Satinjet®**
SQUARE OVERHEAD
SHOWER

WELS MAINS PRESSURE
3★ 8.5L/MIN
WELS LOW PRESSURE
2★ 11L/MIN

> OSQ230CP

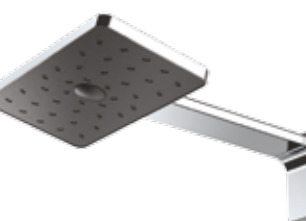

9. **Satinjet®**
TAHĪ OVERHEAD SHOWER
ON WALL ARM

WELS mains pressure
2★ 12L/MIN

> SHTA0CP



To complete the look match with:
Waipori Tapware - See page 36
Kiri Tapware - See page 40
Aio Tapware - See page 20
Maku Tapware - See page 42



ULTRA WIDE COVERAGE

A full-bodied spray for all-over warmth and maximum body contact.



Our tapware and mixer innovations

At Methven we like to make things better. So we spend a great deal of time and effort on research and development to improve our products. Here are just some of our success stories.



Rob Bolus
Head of Technology
29 years of service

METHVEN Fastflow®

Unrivalled performance on unequal pressure installations

Our unique Fastflow® technology delivers unrivalled performance on unequal pressure installations. It has been used and trusted by New Zealand plumbers for over 20 years.

Using precision engineered jets, Fastflow® ingeniously uses high pressure cold water velocity to draw the low pressure hot water through at an increased rate. This provides maximum water flow at the optimum temperature.

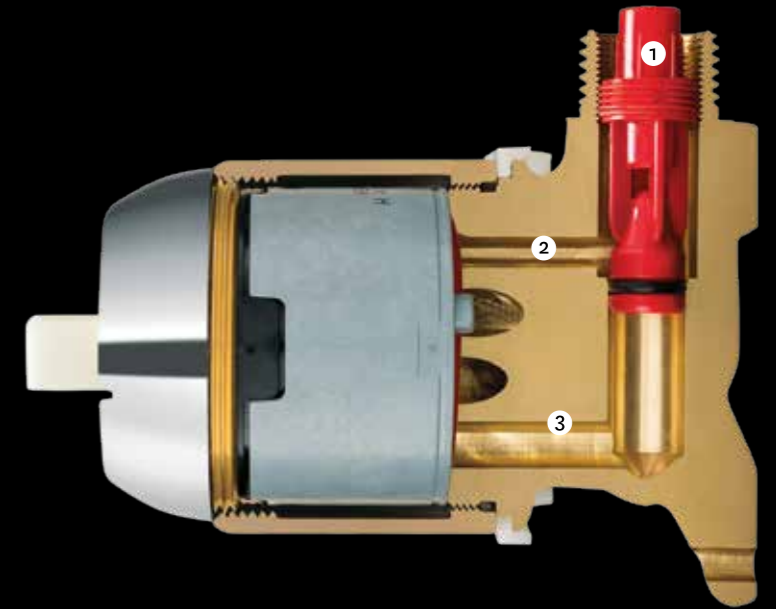

1. Precision engineered jet uses a venturi system to draw the hot water through at an increased rate
2. Hot waterway flows around the outside of the jet
3. Cold waterway flows through the inside of the jet

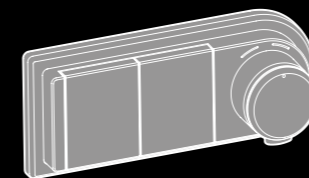

THERMOSTATIC MIXING

Safer and more convenient temperature control

Thermostatic mixers maintain your desired temperature, using clever technology that monitors and continually regulates the temperature level.

Your pre-determined water temperature is maintained, and if somebody uses a tap elsewhere, the self-regulating technology prevents the water from suddenly running cold or hot. Additionally, in the event of a cold water supply failure, the thermostat detects the problem and immediately shuts off the hot water supply - an excellent safety feature.

Suitable for mains pressure only.

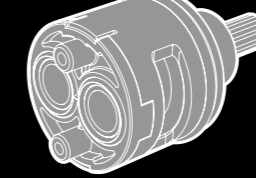

CERAMIC DISCS

Reliable technology that saves water - and money

Ceramic discs ensure your taps work well, are safe to use and help you to conserve water.

A more durable replacement for conventional washers, ceramic discs won't wear out - which means dripping taps are a thing of the past.

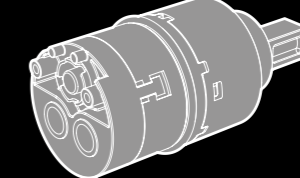

SAFEFLOW™

The answer to safer showering

Safeflow is a temperature and flow regulator that is operated by a simple-to-use single lever. It delivers a stable showering temperature, even with erratic hot and cold pressure.

Precision ceramic discs add incrementally more cold water to the flow as you choose, resulting in a very accurate and stable output temperature to a maximum 45°. If the cold water cuts off for any reason, the thermal element quickly expands to shut off the hot water, preventing exposure to scalding water straight from the water heater.

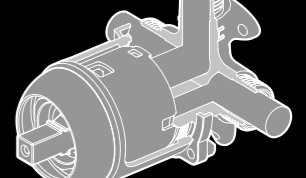

HYPERFLOW™

Faster flow from low pressure systems

An ingeniously simple solution for faster-filling baths and greater shower flow. Upgrade your shower and bath mixers with Methven Hyperflow™ to get significantly better water flow from your existing low pressure plumbing.

**Designed specifically for Equal Low Pressure plumbing systems: check with your plumber if this solution will work for you.*

Aroha

The concept behind Aroha was to organically link the handle and body, as if they were one form. The floating handle gracefully rotates over the tap body, making Aroha a pleasure to use and behold.



CERAMIC CARTRIDGE
Fitted with a quality ceramic cartridge for all-round durability and longevity.

LONGER LASTING TAPS
Dezincification Resistant (DZR) brass bodies last longer and help maintain water quality.



- 1. AROHA BASIN MIXER**

WELS mains pressure
4★ 6.5L/MIN
WELS low pressure
6★ 3.5L/MIN
> ARBCP
- 2. AROHA 3 HOLE BATH SET**

> ARBHCP
- 3. AROHA HOB MOUNTED SWIVEL BATH SPOUT**

> ARSPH190CP
- 4. AROHA WALL MOUNTED MIXER WITH SPOUT**

WELS mains pressure
4★ 7L/MIN
> ARWSLCP
- 5. AROHA 3 HOLE WALL MOUNTED SET**

WELS mains pressure
4★ 7L/MIN
WELS low pressure
2★ 11L/MIN
> ARBWCP
- 6. AROHA WALL MOUNTED BATH SPOUT**

> ARSPW190CP
- 7. AROHA SHOWER MIXER**

> ARHPUSCP
- 8. AROHA SHOWER MIXER WITH DIVERTER**

> ARSHDCP
- 9. Fastflow® AROHA SHOWER MIXER**

> ARSHCP

Surface

The Surface tapware range combines clean lines with elegant floating planes, creating a refined contemporary architectural aesthetic.



LEAD FREE BRASS

Using Eco Brass® to protect water quality and for enhanced corrosion resistance (excludes Fastflow Surface Shower Mixer).

CERAMIC CARTRIDGE

Fitted with a quality ceramic cartridge for all-round durability and longevity.

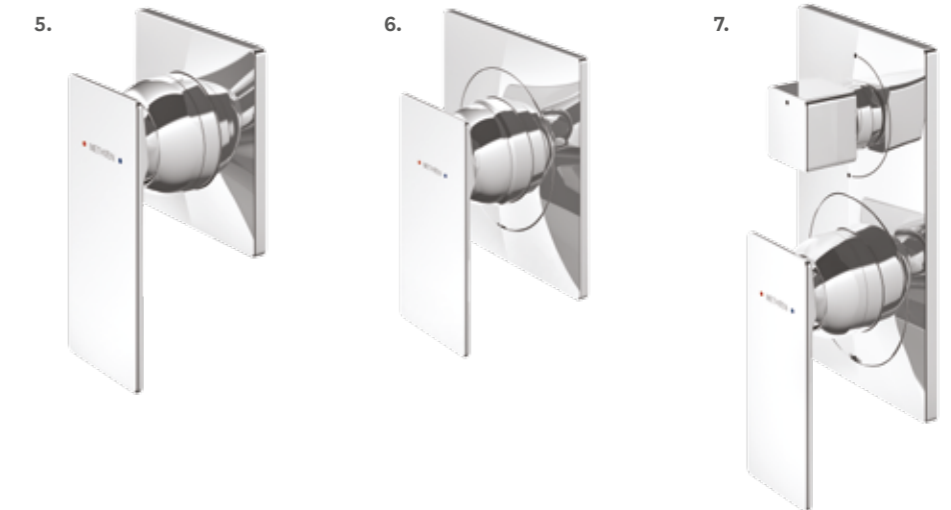

1. SURFACE BASIN MIXER

WELS mains pressure
4★ 6.5L/MIN
WELS low pressure
5★ 5L/MIN

> SFBCP



2. SURFACE MINI BASIN MIXER

WELS mains pressure
4★ 7L/MIN
WELS low pressure
5★ 5L/MIN

> SFBMCP



5. SURFACE SHOWER MIXER

> SFHPSCP



3. SURFACE WALL MOUNTED MIXER WITH SPOUT

WELS mains pressure
4★ 6.5L/MIN

> SFWBSCP



6. Fastflow® SURFACE SHOWER MIXER

> SFAPSCP



4. SURFACE WALL MOUNTED BATH SPOUT

> SFSPWBTCP



7. SURFACE SHOWER MIXER WITH DIVERTER

> SFHPSDCP



Minimalist

Inspired by Italian design, this elegant tapware features strict geometry and intersecting cylinders. A simply beautiful range that will enhance any room with its graceful forms.



1. MINIMALIST BASIN MIXER

WELS mains pressure
3★ 8L/MIN
WELS low pressure
4★ 7.5L/MIN
> MMBCP



2. MINIMALIST HI RISE BASIN MIXER

WELS mains pressure
3★ 8L/MIN
WELS low pressure
4★ 7.5L/MIN
> MMBTCP



3. MINIMALIST 3 HOLE SET

WELS mains pressure
3★ 8L/MIN
WELS low pressure
2★ 12L/MIN
> MMBHRCP



4A. MINIMALIST WALL MOUNTED BATH SPOUT (160MM)

> SPMM160CP



4B. MINIMALIST WALL MOUNTED BATH SPOUT (200MM)

> SPMM200CP



5. MINIMALIST WALL MOUNTED MIXER WITH SPOUT

WELS mains pressure
3★ 8L/MIN
> MMBWSLCP



6. MINIMALIST 3 HOLE WALL MOUNTED SET

WELS mains pressure
3★ 8L/MIN
WELS low pressure
2★ 12L/MIN
> MMBWCP



7. MINIMALIST MINI SHOWER MIXER

> MMHPUSCP



8A. MINIMALIST SHOWER MIXER

> MMHSPCP



8B. Fastflow® MINIMALIST SHOWER MIXER

> MMSCP



9. MINIMALIST SHOWER MIXER WITH DIVERTER

> MMSDCP



Awa

Proven New Zealand engineering with a contemporary design twist, suited to both traditional and modern interiors.



Belaire

Inspired by nature and well over a century of Methven craftsmanship, the Belaire range finds its expression in elegant curves which cleverly contrast the modern technology within.



1.



1. AWA BASIN TAP

Mains zero rated
WELS low pressure
2★ 11L/MIN
STD > AW623
CD > AW624



2.



2. AWA BATH TAP

STD > AW49320
CD > AW49420



3.



3. AWA SHOWER TAP

STD > AW453
CD > AW454



4. AWA 3 HOLE BASIN SET

WELS mains pressure
3★ 8L/MIN
WELS low pressure zero rated
> AW318



5.



5. AWA 3 HOLE WALL MOUNTED BATH SET

STD > AW383



1.



1. BELAIRE BASIN TAP

WELS mains pressure zero rated
WELS low pressure
2★ 11L/MIN
STD > BA623CP
CD > BA624CP



2.



2. BELAIRE 3 HOLE WALL MOUNTED BATH SET

15MM STD > BA383CPCP
15MM CD > BA384CPCP
20MM STD > BA38320CPCP
20MM CD > BA38420CPCP



3.



3. BELAIRE 3 HOLE HI RISE BASIN SET

WELS mains pressure
3★ 8L/MIN
WELS low pressure
1★ 16L/MIN
STD > BA318HRCPCP
CD > BA319HRCPCP



4.



4. BELAIRE 3 HOLE BASIN SET

WELS mains pressure
3★ 8L/MIN
WELS low pressure zero rated
STD > BA318CPCP
CD > BA319CPCP



5.



5. BELAIRE 3 HOLE BATH SET

STD > BA383PCPCP
CD > BA384PCPCP



6.



6. BELAIRE SHOWER TAP

15MM STD > BA453CPCP
15MM CD > BA454CPCP
20MM STD > BA45320CPCP
20MM CD > BA45420CPCP



Blaze

Sleek solid square lines, the Blaze tapware range is the latest in modern styling. Clean sharp lines blended with bold edges, the Blaze range completes and compliments modern geometric shaped décor

CERAMIC CARTRIDGE

Fitted with a quality ceramic cartridge for all-round durability and longevity.

LONGER LASTING TAPS

Dezincification Resistant (DZR) brass bodies last longer and help maintain water quality.



Celeste

One of Methven's most practical, easy-to-use tapware ranges, Celeste is ergonomically designed with curving oval lines.

CERAMIC CARTRIDGE

Fitted with a quality ceramic cartridge for all-round durability and longevity.

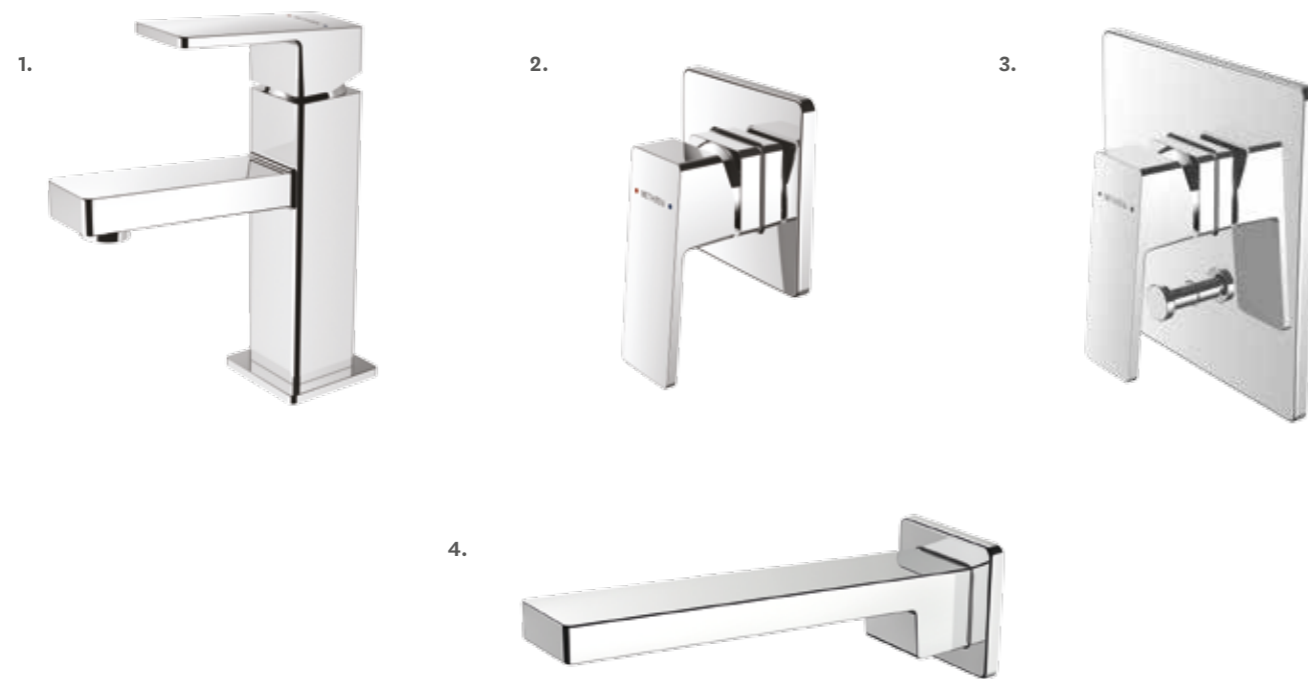

1. BLAZE BASIN MIXER

WELS mains pressure
5★ 6L/MIN
> BLBCP



2. BLAZE SHOWER MIXER

> BLHPSCP



3. BLAZE SHOWER MIXER WITH DIVERTER

> BLHPSDCP



4. BLAZE WALL MOUNTED BATH SPOUT

> BLSPWBTCP



1. CELESTE BASIN MIXER

WELS mains pressure
3★ 8L/MIN
WELS low pressure
3★ 8.5L/MIN
> TPBCP



2. CELESTE WALL MOUNTED BATH MIXER

> TP2080CP



3. Fastflow[®] CELESTE SHOWER MIXER

> TP5HCP



4. Fastflow[®] CELESTE JUMBO SHOWER MIXER

> TP5JCP



Glide

The Glide range is a perfect addition to any contemporary bathroom. Elegant flowing lines, organic curves and an easy to use solid handle results in a complete range which is both functional and beautiful

CERAMIC CARTRIDGE

Fitted with a quality ceramic cartridge for all-round durability and longevity.

LONGER LASTING TAPS

Dezincification Resistant (DZR) brass bodies last longer and help maintain water quality.



Neon

Crisp and sharp, the Neon tapware range is unashamedly geometric.

CERAMIC CARTRIDGE

Fitted with a quality ceramic cartridge for all-round durability and longevity.

LONGER LASTING TAPS

Dezincification Resistant (DZR) brass bodies last longer and help maintain water quality.

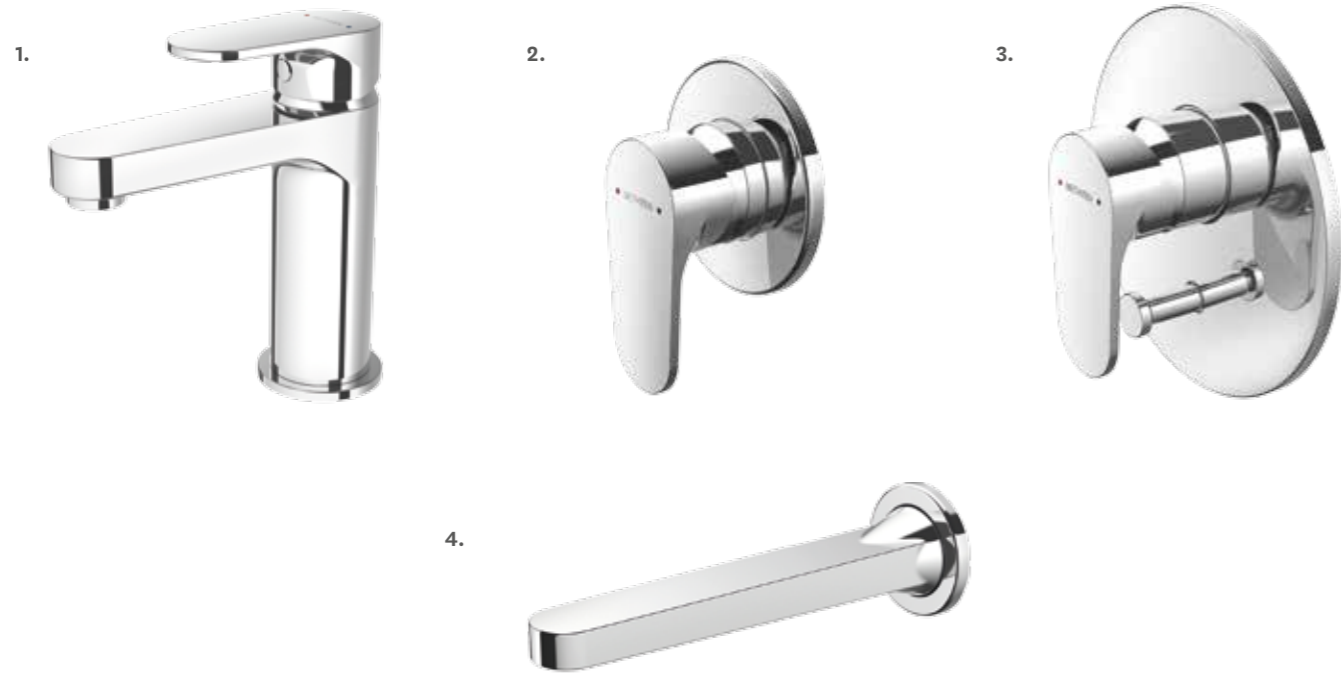

1. GLIDE BASIN MIXER

WELS mains pressure
5★ 6L/MIN
> GLBCP



2. GLIDE SHOWER MIXER

> GLHPSCP



3. GLIDE SHOWER MIXER WITH DIVERTER

> GLHPSDCP



4. GLIDE WALL MOUNTED BATH SPOUT

> GLSPWBTCP



1. NEON BASIN MIXER

WELS mains pressure
5★ 6L/MIN
> NEBCP



2. NEON SHOWER MIXER

> NEHPSCP



3. NEON SHOWER MIXER WITH DIVERTER

> NEHPSDCP



Promix

Clean, uncluttered design and sturdy construction makes Promix equally at home for domestic and commercial uses. It is compatible with a wide range of decors.

CERAMIC CARTRIDGE

Fitted with a quality ceramic cartridge for all-round durability and longevity.



Bath Fillers

Our modern floor mounted bath fillers are the perfect partner for your free standing bath.

CERAMIC CARTRIDGE

Fitted with a quality ceramic cartridge for all-round durability and longevity.



1. PROMIX BASIN MIXER MP

WELS mains pressure
3★ 8L/MIN
> PRSLBCP



2. PROMIX SWIVEL BASIN MIXER

WELS mains pressure
4★ 7.5L/MIN
WELS low pressure
5★ 6L/MIN
> PRBSWCP



3. PROMIX MINI BASIN MIXER

WELS mains pressure
3★ 8L/MIN
WELS low pressure
5★ 6L/MIN
> PRBMCP



4. PROMIX SHOWER MIXER

> PRSHCP



5. PROMIX SHOWER MIXER WITH DIVERTER

> PRSHDCP



1. MINIMALIST FLOOR MOUNTED BATH FILLER

WELS mains pressure
1★ 15L/MIN
> MMBFCP



2. SQUARE FLOOR MOUNTED BATH FILLER

WELS mains pressure
1★ 15L/MIN
> SQBFCP



Spouts

A diverse range of standalone spouts to easily match to your basin or bath shape and style.



- | | | | |
|--|---|---|--|
| <p>1. AIO WALL MOUNTED BATH SPOUT (200MM)</p> <p>CHROME > AOSPWBTCP
MATTE BLACK > AOSPWBTBK</p> <p>(A) (ECO)</p> | <p>2. AROHA HOB MOUNTED SWIVEL BATH SPOUT (190MM)</p> <p>> ARSPH190CP</p> <p>(A) (DZR) (S)</p> | <p>3. AROHA WALL MOUNTED BATH SPOUT (191MM)</p> <p>> ARSPW190CP</p> <p>(A) (DZR)</p> | |
| <p>4. KOHA WALL MOUNTED BATH SPOUT (200MM)</p> <p>> KOSP200CP</p> <p>(A) (DZR)</p> | <p>5. WAIPORI WALL MOUNTED BATH SPOUT (203MM)</p> <p>CHROME > WASPW200CP
MATTE BLACK > AOSPWBTBK</p> <p>(A) (DZR) (S)</p> | <p>6. WAIPORI HOB MOUNTED BATH SPOUT (198MM)</p> <p>> WASPH200CP</p> <p>(A) (DZR) (S) (S)</p> | <p>7. SURFACE WALL MOUNTED BATH SPOUT (204MM)</p> <p>> SFSPWBTCP</p> <p>(NEW) (A) (ECO)</p> |
| <p>8. MAKU WALL MOUNTED BATH SPOUT (212MM)</p> <p>> MASPW210CP</p> <p>(A) (DZR)</p> | <p>9. KIRI WALL MOUNTED BATH SPOUT (172MM)</p> <p>> KISP172CP</p> <p>(A) (DZR)</p> | <p>10. MINIMALIST WALL MOUNTED BATH SPOUT</p> <p>160MM > SPMM160CP
200MM > SPMM200CP</p> <p>(A)</p> | <p>11. BLAZE WALL MOUNTED BATH SPOUT</p> <p>> BLSPWBTCP</p> <p>(NEW) (M) (DZR)</p> |
| <p>12. GLIDE WALL MOUNTED BATH SPOUT</p> <p>> GLSPWBTCP</p> <p>(NEW) (M) (DZR)</p> | <p>13. WALL MOUNTED BATH SPOUT (180MM)</p> <p>> 388CP</p> <p>(A)</p> | <p>14. WALL MOUNTED BATH SPOUT (165MM)</p> <p>> SP99CP</p> <p>(A)</p> | <p>15. HOB MOUNTED BATH SPOUT (160MM)</p> <p>> SP96CP</p> <p>(A)</p> |

Your kitchen, the heart of your home

You spend more active time in the kitchen than any other room in the house, and your kitchen tapware is at the heart of this - so it's important to select the tapware that's right for you.



Think about how you use your kitchen tapware:

Whether you're looking to buy kitchen tapware as part of a renovation, new build or simply because your current mixer is in need of replacement, it's important to think about the everyday tasks you use it for. For example, food preparation, washing dishes, rinsing dishes, making drinks, washing hands or even watering your plants. Considering all the facts will help you choose the right combination of features.

Choosing the right kitchen tap:

1. CONSIDER THE MOUNTING TYPE - DO YOU WANT IT DECK (BENCH) OR WALL MOUNTED:

Deck mounted - Is a more contemporary look and gives you greater flexibility for kitchen sink placement.

Wall mounted - Gives a more classic look and is more cost effective if you're replacing an old wall-mounted kitchen tap.

2. CONSIDER HOW YOU WANT TO CONTROL YOUR KITCHEN TAP:

Mixers - Contemporary look and simple single handed operation.

Also, if you prefer a mixer do you want the handle positioned on the side, front or top? Methven have deck mounted mixers that allow you to position the handle at either the front or side.

Separate handles - The classic look, allowing you to control the cold and hot water individually.



3. CONSIDER YOUR SPOUT HEIGHT - HIGH VS LOW:

High spout - Gives a more contemporary look and makes filling large pots much easier.

Low spout - Is great when space is at a premium, such as when you have a cabinet or window above the sink.

4. WHAT ABOUT A PULL-OUT SPOUT:

This is a feature where the spout head pulls out towards the sink on a flexible hose, giving increased flexibility and manoeuvrability - very handy for cleaning vegetables, rinsing pots and pans or rinsing down the sink.

Sink Mixers

Single-lever mixers with a taller spout to suit both kitchen and laundry sinks. With the convenience of easy one-handed temperature and flow control.



- | | | | |
|---|--|--|--|
| <p>1. AROHA SINK MIXER</p> <p>WELS mains pressure
4★ 7L/MIN
WELS low pressure
4★ 7.5L/MIN
> ARKCP</p> | <p>2. AROHA SINK MIXER MP</p> <p>WELS mains pressure
4★ 6.5L/MIN
> ARKHCP</p> | <p>3. KOHA SINK MIXER</p> <p>WELS mains pressure
4★ 6.5L/MIN
WELS low pressure
4★ 7L/MIN
> KOKSLCP</p> | <p>4. TAHI SINK MIXER</p> <p>WELS mains pressure
4★ 6.5L/MIN
WELS low pressure
4★ 6.5L/MIN
> TAKCP</p> |
| <p>5. WAIPORI SINK MIXER</p> <p>WELS mains pressure
4★ 6.5L/MIN
WELS low pressure
4★ 7L/MIN
CHROME > WAKCP
MATTE BLACK > WAKBK</p> | <p>6. MAKU SINK MIXER</p> <p>WELS mains pressure
4★ 7L/MIN
WELS low pressure
4★ 7L/MIN
> MAKCP</p> | <p>7. KIRI SINK MIXER</p> <p>WELS mains pressure
4★ 6.5L/MIN
WELS low pressure
4★ 7.5L/MIN
> KIKCP</p> | <p>8. MINIMALIST SINK MIXER</p> <p>WELS mains pressure
3★ 8L/MIN
WELS low pressure
3★ 8L/MIN
> MMKCP</p> |

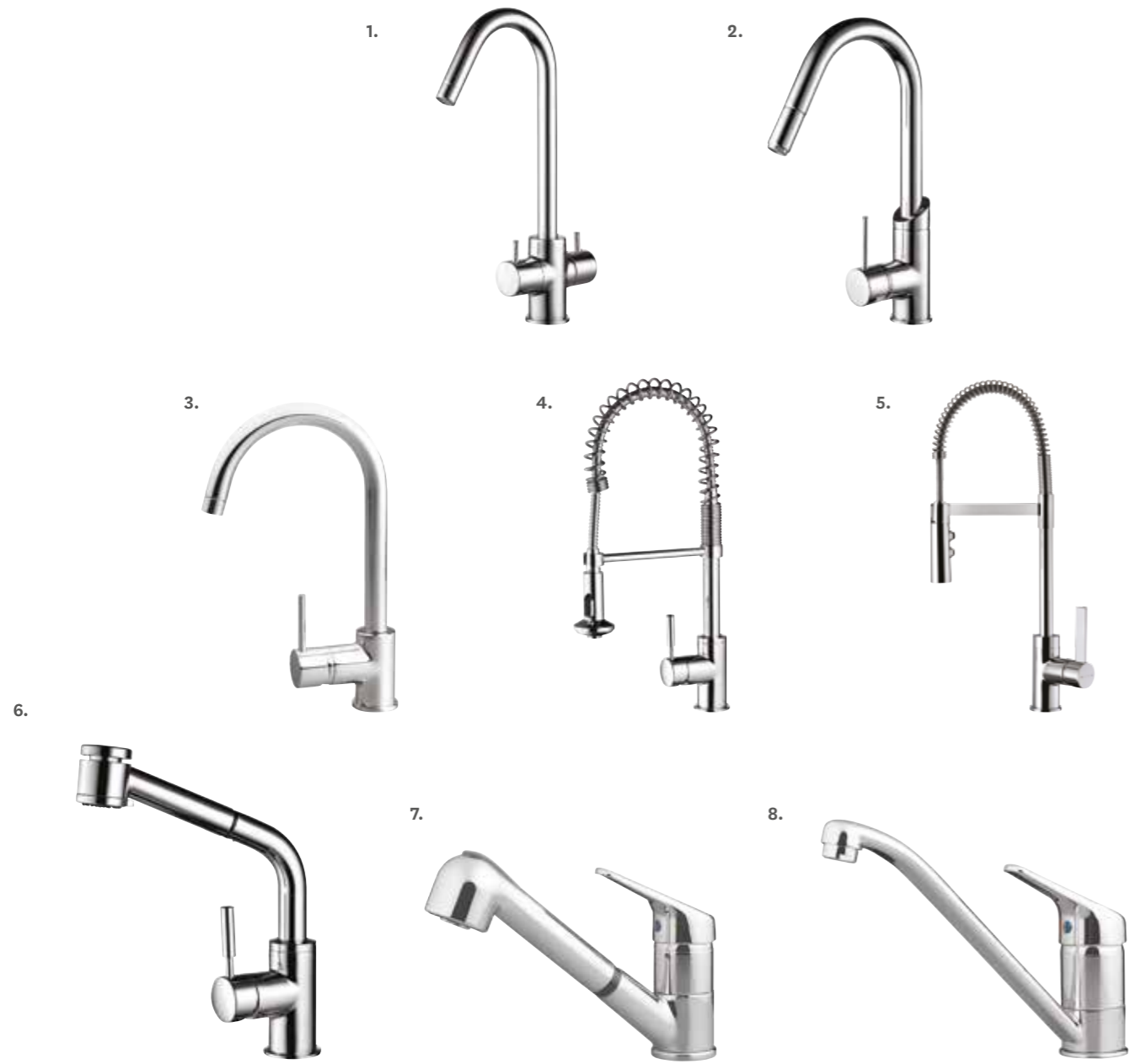

1. MINIMALIST SINK MIXER WITH TWIN HANDLES

WELS mains pressure
3★ 8L/MIN
WELS low pressure
3★ 9L/MIN
> MMKHRTW



5. GASTON PULL DOWN SINK MIXER

WELS mains pressure
4★ 6.5L/MIN
CHROME > GAKCP
BRUSHED > GAKBF
BLACK ACCENT > GAKBK
BRUSHED & BLACK ACCENT > GAKBFBK



2. MINIMALIST SINK MIXER WITH PULL OUT SPRAY

WELS mains pressure
4★ 7L/MIN
> MMKHRPD



6. CENTIQUE HI RISE VEGIE SPRAY SINK MIXER

WELS mains pressure
4★ 7L/MIN
> HR2030



3. MINIMALIST GOOSENECK SINK MIXER

WELS mains pressure
3★ 8L/MIN
WELS low pressure
3★ 8L/MIN
> MMKHRCF



7. CENTIQUE SINK MIXER WITH VEGIE SPRAY

WELS mains pressure
4★ 7.5L/MIN
> VS2030



4. MINIMALIST PULL DOWN SINK MIXER

WELS mains pressure
4★ 7L/MIN
> MMKSPR



8. CENTIQUE SINK MIXER

WELS mains pressure
3★ 8L/MIN
WELS low pressure
3★ 9L/MIN
> CENSINK



1. BLAZE SINK MIXER

WELS mains pressure
5★ 6L/MIN
> BLKCP



3. GLIDE SINK MIXER

WELS mains pressure
5★ 5.5L/MIN
> GLKCP



7. AWA SINK TAP

Mains zero rated
WELS low pressure
2★ 10.5L/MIN
STD > AW49315
CD > AW49415



2. NEON SINK MIXER

WELS mains pressure
5★ 6L/MIN
> NEKCP



4. PROMIX SINK MIXER

WELS mains pressure
3★ 8L/MIN
WELS low pressure
3★ 9L/MIN
> PRSLSCP



8. BELAIRE SINK TAP

WELS mains pressure zero rated
WELS low pressure
2★ 10.5L/MIN
STD > BA49315CP
CD > BA49415CP



5. FUTURA SINK MIXER

WELS mains pressure
3★ 8L/MIN
WELS low pressure
3★ 9L/MIN
> FTKCP



9. AWA SINK FAUCET

WELS mains pressure
3★ 8L/MIN
WELS low pressure
1★ 14L/MIN
STD > AW34315
CD > AW344



6. CELESTE SINK MIXER

WELS mains pressure
3★ 8L/MIN
WELS low pressure
3★ 8.5L/MIN
> TPKCP



10. BELAIRE SINK FAUCET

WELS mains pressure
3★ 8L/MIN
WELS low pressure
1★ 16L/MIN
STD > BA343CP
CD > BA344CP



Awards

2015



Australian International Design Award
GOOD DESIGN® Selection
Aio Tapware Collection



Chicago Athenaeum GOOD DESIGN™ Award Winner
Aurajet® Aio Showers
Aio Tapware Collection



Best Design Awards Winner 2015
New Zealand BEST Design Awards
Gold, Product, Consumer
Aurajet® Aio Showers



Best Design Awards Winner 2015
New Zealand BEST Design Awards
Silver, Product, Consumer
Aio Tapware Collection

WINNER
NEW ZEALAND INNOVATORS AWARDS® 2015

New Zealand Innovators Awards Winner:
- Innovation in Design & Engineering
- Export Innovator of the Year
Aurajet® Aio Showers



UK 2015 Kitchen & Bathroom Designer Awards
Gold, Innovation in Sustainability
Aurajet® Aio Showers



UK CoolBrands Award 2015/2016
Winner, Home - General Products

2016



reddot design award winner 2016
Red Dot Award
Product Design Winner
Aurajet® Aio Showers



Australian International Design Award
GOOD DESIGN® Award
Aurajet® Aio Shower System



Best Design Awards Winner 2016
New Zealand BEST Design Awards
Silver, Product, Consumer
Aurajet® Aio Shower System



Best Design Awards Winner 2016
New Zealand BEST Design Awards
Bronze, Product, Consumer
Surface Tapware Collection



UK CoolBrands Award 2016/2017
Winner, Home - Hard Furnishings



House Beautiful Award 2016
Best Bathroom - Gold Winner
Aurajet® Aio Overhead Shower

2017



reddot design award best of the best 2017
Red Dot Award
Best of the Best
Aurajet® Aio Shower System



2017 UK Bathroom & Kitchen Update (BKU) Awards
Award Winner
Best Shower Brand of the Year



Chicago Athenaeum GOOD DESIGN™ Award Winner
Aurajet® Aio Shower System
Surface Tapware Collection



German Design Award Special Mention
Aurajet® Aio Showers



Plus X Design Award Award Winner
Aurajet® Aio Handset



Plus X Design Award Award Winner
Aio Basin Mixer



Plus X Design Award Award Winner
Most Innovative Brand



ExportNZ Awards 2016 Award Winner
Best Use of Commercialisation of Innovation for Export

BALDWIN'S INTELLECTUAL PROPERTY BEST USE OF COMMERCIALISATION OF INNOVATION FOR EXPORT



METHVEN

methven.com

NEW ZEALAND

Methven Limited
41 Jomac Place
Avondale
Auckland 1026
New Zealand
Phone: 0800 804 222

AUSTRALIA

Methven Australia Pty Limited
16 Gipps Street, Collingwood
Victoria 3066
Australia
Phone: 1300 638 483

UNITED KINGDOM

Methven UK Limited
Methven Experience Centre
3/3A Stone Cross Court, Yew Tree Way
Golborne, Warrington
WA3 3JD
United Kingdom
Phone: 0800 195 1602

CHINA

Methven Heshan Bathroom
Fitting Co. Limited
A, Dong Xi Development Zone
Zhishan Town, Heshan City
Guangdong Province
China
Phone: 400 889 2080

Please note: While every effort is made to ensure that the details in this brochure were correct at the time of printing, Methven reserves the right to alter specifications or product from that shown.



This brochure is produced using Elemental Chlorine Free (ECF) pulp sourced from farmed eucalyptus trees and manufactured under the strict ISO14001 Environmental Management System. Printed with soy-based printing inks.